

Differential Probes

N2792A/N2818A 200 MHz and N2793A/N2819A 800 MHz

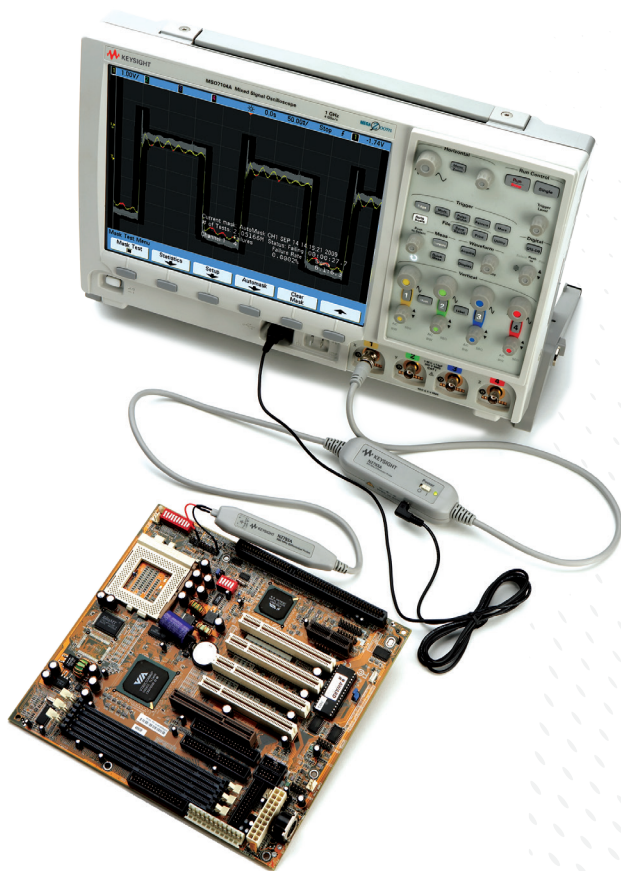

Introduction

The Keysight Technologies, Inc. N2792A/93A and N2818A/19A differential probes provide the superior general-purpose differential signal measurements required for today's high-speed power measurements, vehicle bus measurements and digital system designs.

The differential probes offer a 10:1 attenuation setting, allowing them to be used for a broad range of applications. The probes come with various probe tip accessories for use with small and large components in tight places.

The differential probes have an input resistance of 1 M Ω (for N2792A/N2818A) and 200 k Ω (for N2793A/N2819A) and a low input capacitance of 3.5 pF (for N2792A/N2818A) and 1 pF (for N2793A/N2819A) to minimize circuit loading. Both N2792A and N2793A probe are compatible with any oscilloscope with 50 Ω BNC inputs. The probe can be powered by any USB port on a scope or computer, or by an internal battery (1x 9V battery included). The N2818A and N2819A are compatible with the Keysight Technologies, Inc. AutoProbe interface where the probe power is supplied by the oscilloscope's probe interface.

N2792A/N2818A 200 MHz Differential Probe – Plots



Figure 1. N2792A 200 MHz differential probe with standard accessories



Figure 2. N2818A 200 MHz differential probe with AutoProbe interface

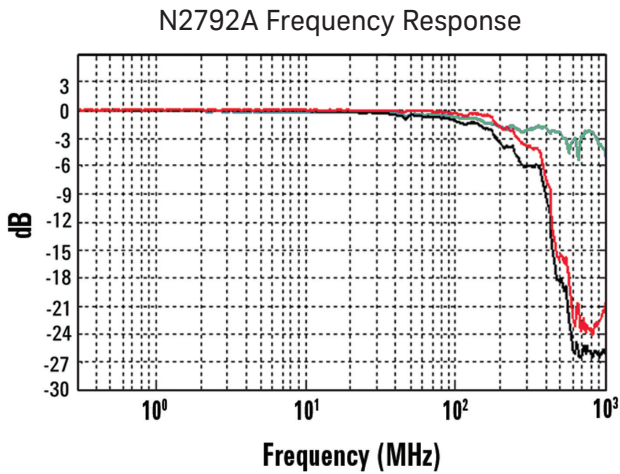

Figure 3. V_{out}/V_{in} vs. Frequency response of N2792A/N2818A (red = V_{out}/V_{in} , green = V_{in} , black = V_{out})

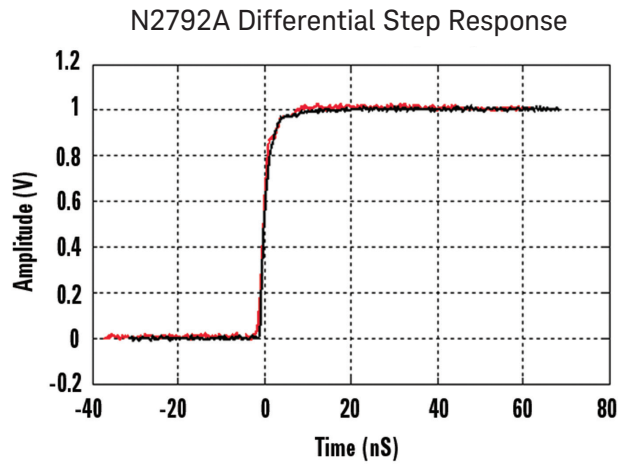

Figure 4. Normalized differential step response of N2792A/N2818A (red = measured step response, rise time = 3.5 nsec for 10-90%, black = input step signal, 3.5 nsec for 10-90%)

N2792A/N2818A 200 MHz Differential Probe – Plots (continued)

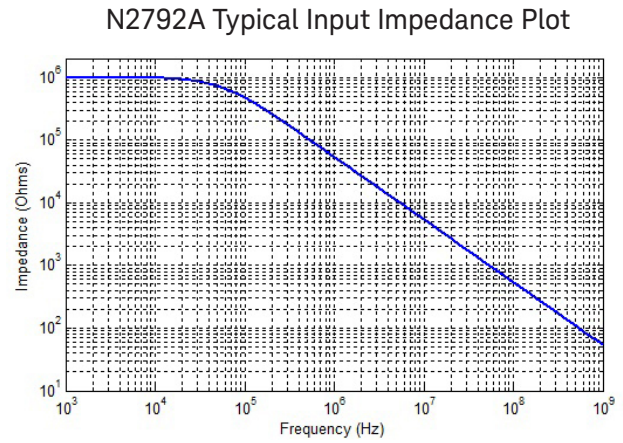
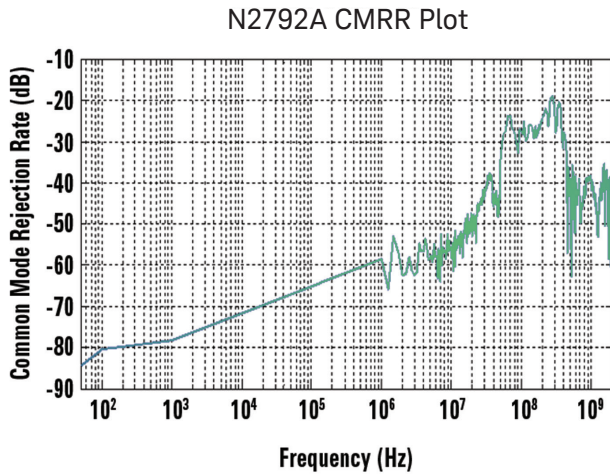

Figure 5. Frequency response (V_{out}/V_{in}) of N2792A/N2818A when inputs driven in common (Common Mode Rejection)

Figure 6. Input impedance vs. Frequency of N2792A/N2818A

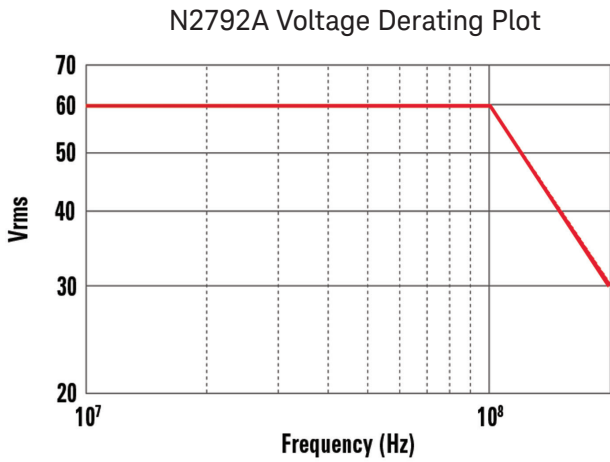

Figure 7. Voltage derating curve of N2792A/N2818A (voltage between either input and ground)

N2793A/N2819A 800 MHz Differential Probe – Plots



Figure 8. N2793A 800 MHz differential probe with standard accessories



Figure 9. N2819A 800 MHz differential probe with AutoProbe interface

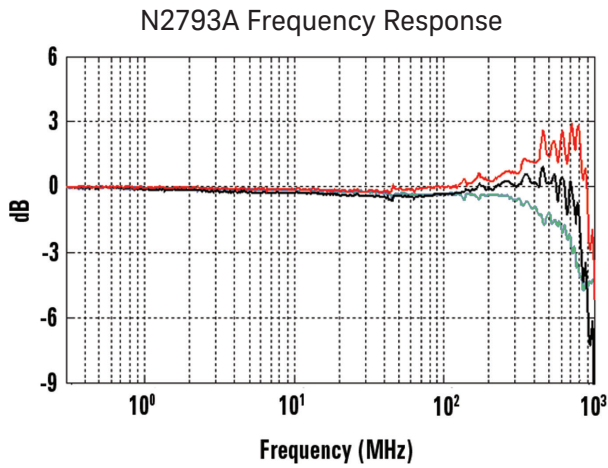

Figure 10. V_{out}/V_{in} vs. Frequency response of N2793A /N2819A (red = V_{out}/V_{in} , green = V_{in} , black = V_{out})

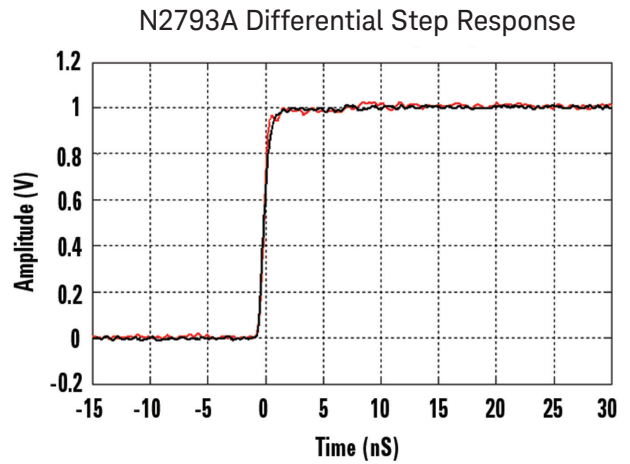

Figure 11. Normalized differential step response of N2793A/N2819A (red measured step response, rise time = 900 psec for 10-90%, black = input step signal, 900 psec for 10-90%)

N2793A/N2819A 800 MHz Differential Probe – Plots (continued)

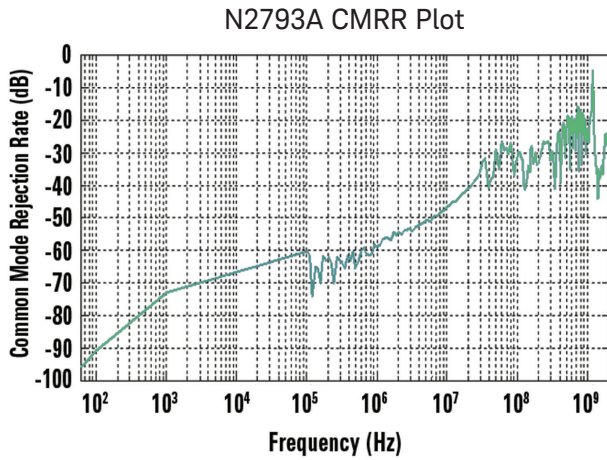

Figure 12. Frequency response (V_{out}/V_{in}) of N2793A/N2819A when inputs driven in common (Common Mode Rejection)

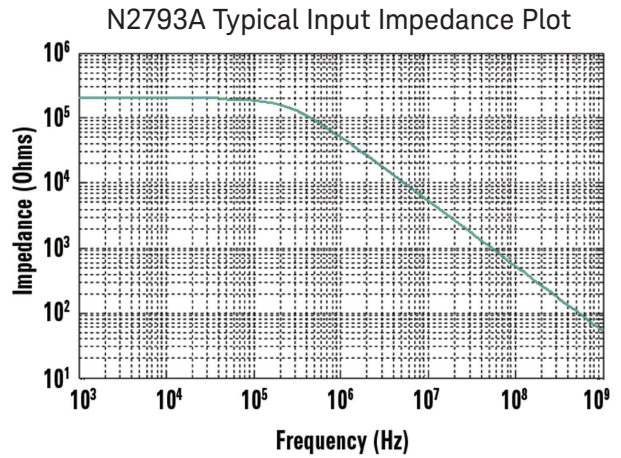

Figure 13. Input impedance vs. Frequency of N2793A/N2819A

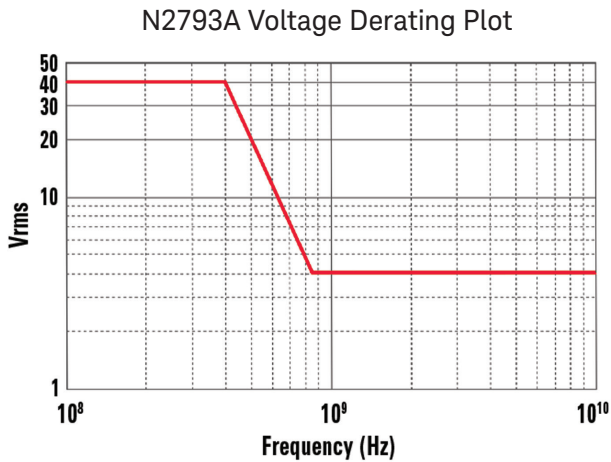

Figure 14. Voltage derating curve of N2793A/N2819A (voltage between either input and ground)



Figure 15. N2793A differential probe with its standard case



Figure 16. Use the N2793A/N2819A with a DC blocking capacitor to block out unwanted DC components of the input signal



Figure 17. The variable pitch spacing adapter that fits over the N2793A/N2819A allows you to probe two adjacent IC leads or test points easily

Performance Characteristics and Specifications

Characteristics	N2792A/N2818A	N2793A/N2819A
Bandwidth (-3 dB)	200 MHz	800 MHz
Attenuation	10:1	10:1
Probe Rise time (10% - 90%)	1.75 nsec	437 psec
Gain accuracy (% of reading)	±2%	±2%
Absolute Maximum Rated Input Voltage (each side to ground)	±60 V	±40 V
Maximum Differential Input Voltage (DC + AC peak)	±20 V	±15 V
Maximum Common Mode Input Voltage	±60 V	±30 V
Input Resistance // Capacitance	500 kΩ // 7 pF (each side to ground) 1 MΩ // 3.5 pF (between inputs)	100 kΩ // 2 pF (each side to ground) 200 kΩ // 1 pF (between inputs)
Output Voltage Swing	±2 V (driving 50 Ω scope input)	±1.5 V (driving 50 Ω scope input)
Offset (typical)	±2 mV	±5 mV
Offset adjustment range	-95 mV to +95 mV	-20 mV to +20 mV
AC CMRR	> -80 dB at 50/60 Hz > -50 dB at 10 MHz	> -60 dB at 50/60 Hz > -15 dB at 500 MHz
Noise referenced to input, probe only	6 mVrms	4.7 mVrms
Power Requirements	N2792A: One 9V battery or USB power cord (5 V to 9V, 90mA), N2818A: AutoProbe interface	N2793A: One 9V battery or USB power cord (5 V to 9V, 90mA), N2819A: AutoProbe interface
Approximate Battery Life (for N2792A/93A only)	7.5 hours (alkaline battery)	4.5 hours (alkaline battery)
Battery/voltage requirements (for N2792A/93A only)	The supplied voltage must be less than 12 V and greater than 4.5 V or else the probe could be damaged	The supplied voltage must be less than 12 V and greater than 4.5 V or else the probe could be damaged
Ambient operating temperature	-10 to +40 °C	-10 to +40 °C
Ambient nonoperating temperature	-30 to +70 °C	-30 to +70 °C
Operating humidity	25 - 85% RH	25 - 85% RH
Non-operating humidity	25 - 85% RH	25 - 85% RH
Operating altitude	3,000 m (9,842 feet)	3,000 m (9,842 feet)
Non-operating altitude	15,300 m (50,196 feet)	15,300 m (50,196 feet)
Pollution Degree	2	2
Approximate weight (not including battery and accessories)	170 g (6 oz)	170 g (6 oz)
BNC cable length (output)	120 cm (47 inches)	120 cm (47 inches)
Input lead length	15 cm (5.9 inches)	
Housing dimension (LxWxH)	111 x 22 x 14 mm (4.4 x 0.9 x 0.6 in)	111 x 22 x 14 mm (4.4 x 0.9 x 0.6 in)
Compatible oscilloscopes	N2792A/93A: Any oscilloscope with 50 ohm BNC input	N2818A/19A: Keysight InfiniiVision 3000 X-, 4000 X- and 6000 X-Series and Infiniium 9000A/H, S-Series, 90000A, 90000X/Q /Z with N5442A

Performance Characteristics and Specifications (continued)

Characteristics	N2792A/N2818A	N2793A/N2819A
Standard accessories	<ul style="list-style-type: none"> - 2 hook clips (black and red) - 2 alligator clips (black and red) - 1 screw driver for offset adjustment - For N2792A only: <ul style="list-style-type: none"> - USB power cord (2m) - 9V battery - user's guide 	<ul style="list-style-type: none"> - 2 pincer clips (black and red) - 2 micro IC clips (black and red) - 2 extension leads, 0.8 mm J-P, 5 cm (black and red) - 2 extension leads, 0.8 mm J-P, 10 cm (black and red) - 2 DC blocking capacitors (30 kHz - 1 GHz, 100V max) - 2 variable pitch spacing adapters - 6 single signal pins, 0.8 mm - 1 screw driver for offset adjustment - For N2793A only: <ul style="list-style-type: none"> - USB power cord (2m) - 9V battery - user's guide
Regulatory markings	CEI/IEC61010-031 CAT II	CEI/IEC61010-031 CAT II

When probing differential signals inside of environmental chambers at extreme temperatures, Keysight offers the N7013A extreme temperature extension kit shown in Figure 18. The N7013A is compatible with the N2792A and N2818A differential probes at de-rated bandwidths. The 70 cm long differential cable set and accessories can operate in temperatures ranging from -40 degrees to +85 degree Celsius. Note that the N7013A is not compatible with the N2793A and N2819A.

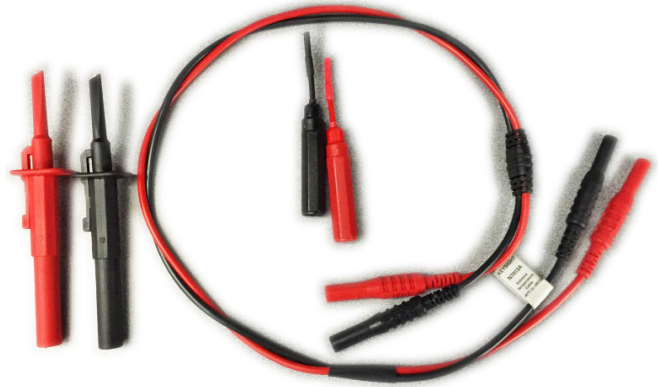
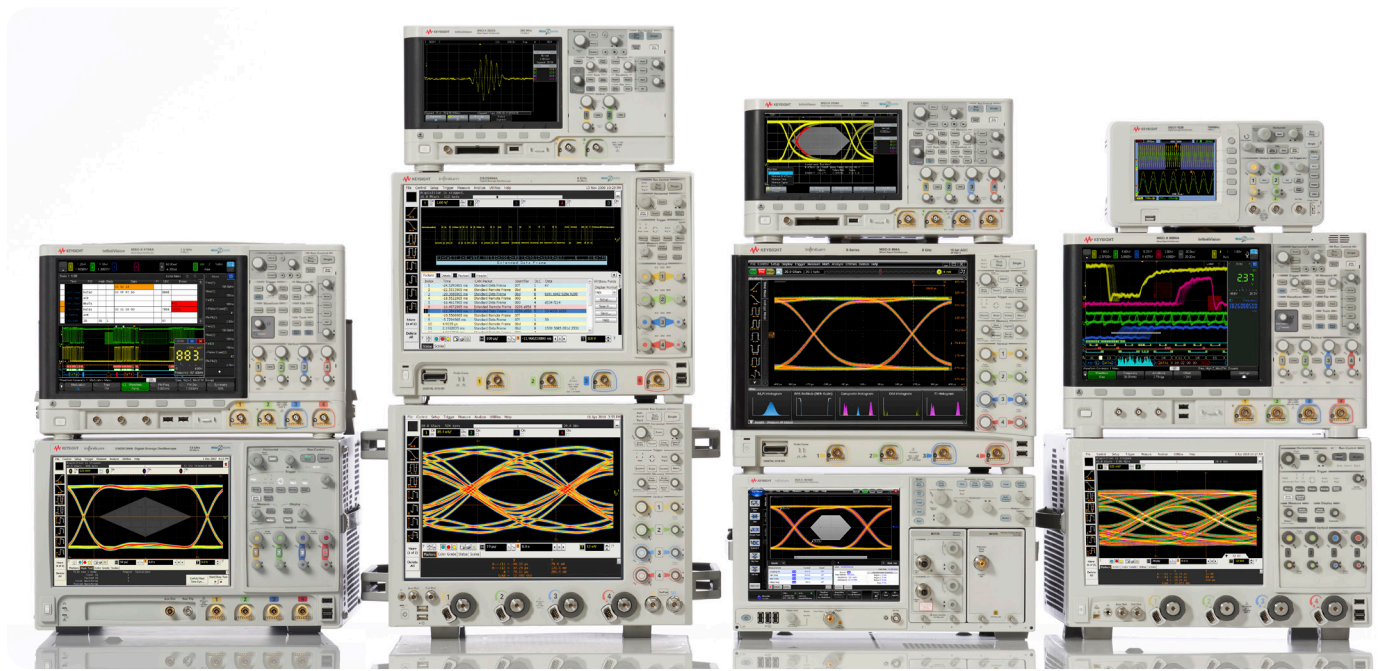

Figure 18. The N7013A extreme temperature probing kit for differential probes

Ordering Information

Product number	Description
N2792A	200 MHz differential probe
N2792-68700	Differential probe accessory kit for N2818A/N2792A (including 2 each clip hook, 2 each alligator clip and USB power cord)
N2793A	800 MHz differential probe
N2793-68700	Differential probe accessory kit for N2819A/N2793A (including 2 each pincer clip, 2 each micro IC clip, 2 each extension lead 0.8 mm J-P 5 cm, 2 each extension lead 0.8 mm J-P 10 cm, 2 dual signal pins 16.8 mm, 2 dual signal pins 12.8 mm, 2 variable pitch spacing adapters, 2 DC blocking capacitors, 6 single signal pins 0.8 mm, USB power cord)
N2818A	200 MHz differential probe with AutoProbe interface
N2819A	800 MHz differential probe with AutoProbe interface
N4853A	Variable pitch browser for N2793A/N2819A, qty 2
N4854A	DC blocking caps for N2793A/N2819A, qty 2
N7013A	Extreme temperature probe kit for the N2792 and N2818A
N7014A	Banana-to-socketed adapters (1 pair) for N2792A/N2818A for connecting to 0.025" square pins (headers)
0960-2926	CAN/CAN FD/FlexRay DB9 probe head for N2792A/N2818A
0960-2927	CAN/CAN FD/FlexRay DB9 probe head for N2793A/N2819A



Keysight Technologies Oscilloscopes

Multiple form factors from 20 MHz to >90 GHz | Industry leading specs | Powerful applications

www.keysight.com/find/differential

Learn more at: www.keysight.com

For more information on Keysight Technologies' products, applications or services, please contact your local Keysight office. The complete list is available at: www.keysight.com/find/contactus

